



## Room thermostat with Auto Timer, Option External Input RDE100..

for heating systems

- Room temperature control
- 2-position / TPI control with On/Off output for heating
- Optimum Start / Stop
- Comfort, Economy, Auto timer and Protection mode
- Auto time switch
- Adjustable commissioning and control parameters
- Mains-powered AC 230 V (RDE100) or battery-powered DC 3 V (RDE100.1)
- Multifunction input (RDE100.1 only) for external floor sensor, keycard contact, etc.

### Use

The RDE100.. is used to control the room temperature in heating systems.

Typical applications:

- Apartments
- Commercial spaces
- Schools

For the control of the following pieces of equipment:

- Thermal valves or zone valves
- Gas or oil boilers
- Fans
- Pumps
- Floor Heating

## Functions

- Room temperature control via built-in sensor or external input
- Selection of operating mode with operating mode touchkey
- Setting auto time switch (individual day, 7 day or 5-2 day)
- Display of current room temperature or setpoint in °C or °F
- Touchkey lock (manually)
- Setpoint lock
- Periodic pump run
- Optimum start / stop
- Comfort temperature limitation by Economy setpoint locked
- Reloading factory settings for commissioning and control parameters
- One multifunctional input (RDE100.1 only) freely selectable for:
  - Floor Heating temperature limitation function
  - Operating mode switchover contact (keycard, window contact, etc.)

## Temperature control

RDE100.. comprises of both 2-position and TPI temperature controls, which can be configured by parameter P78 (Control behavior).

2-position control algorithm is to switch on and off the heating system within a switching differential according to comparison between setpoint setting and the measured room temperature.

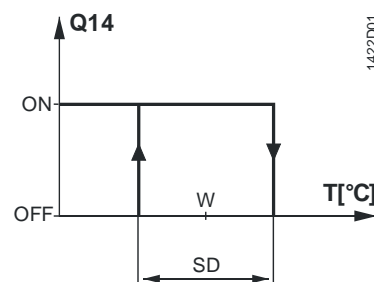

T Room temperature  
 SD Switching differential  
 W Room temperature setpoint  
 Q14 Output signal for heating

TPI (Time proportional Integral) control algorithm is to periodically switch on and off the heating system. The period time and pulse length of the control signal (PWM) are determined by the setpoint and the measured room temperature.

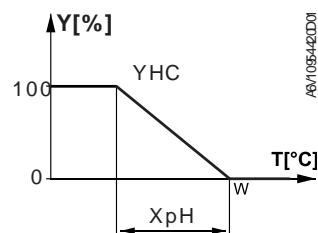

Heating mode  
 T Room temperature  
 Y Output signal for heating (PWM)  
 W Room temperature setpoint  
 YHC Control command "Valve"  
 XpH Proportional band "Heating"

## Floor heating limitation function (RDE100.1 only)

The factory setting for this function is Off (disabled) and must be set to "On" if floor heating is used.

The external floor temperature sensor is connected to input X1,  $\perp$  and acquires the floor temperature. If the floor temperature exceeds the parameterized

temperature limit xx °C (P14 = 1, P15 = 1, P16 = xx °C), the heating valve is fully closed until the floor temperature returns to a level below the parameterized limit. Typical application is rooms (dry floor).

If the application does not require floor heating temperature limitation but instead uses the external sensor as a source for both room temperature display and control, the parameters will have to be set as follows: P14 = 1, P15 = 0. A typical application is the bathroom (wet floor) where a constant floor temperature is required.

It is not recommended to have **only** an internal built-in room sensor for floor heating since there is a potential risk of overheating.

Typical application: Maximum temperature limitation for under floor heating systems

## Operating mode switchover function

---

This function allows keycard application, please refer to the section “Operating notes, Economy mode”.

## Periodic pump run function

Can only be used when circulating pump or valve is controlled!

This function protects the pump or valve against seizing during longer off periods. Periodic pump run is activated for 3 minutes every 24 hours at 12:00.

Parameter	Pump status
P12 = 0 (Default)	Pump run off
P12 = 1	Pump run on

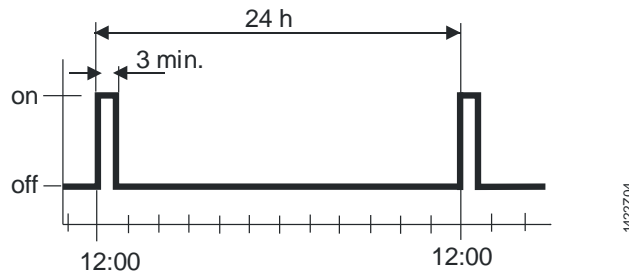

## Optimum start control

The purpose of optimum start control is to reach a temperature level 0.25 K below the Comfort setpoint when occupancy according to the time program starts in Auto timer mode. For that purpose, the heating circuit must be switched on at an earlier point in time. The extent of forward shift depends primarily on the outside temperature.

The maximum forward shift on time can be adjusted by parameter P89. A Forward shift on maximum "0" means the function is disabled.

Parameter	Range	Factory setting
Forward shift on max (P89)	0, 0.5, ... 24 h	0

## Optimum stop control

Optimum stop control switches off the heating circuit at the earliest possible point in time so that the room temperature will lay 0.5 K below the Comfort setpoint when the time switch changes from Comfort mode to Economy mode in Auto timer mode. The early shut down maximum time can be adjusted by parameter P90. Early shut down maximum "0" means the function is disabled.

Parameter	Range	Factory setting
Early shutdown max (P90)	0, 0.5, ... 6 h	0

## Control behavior (P78)

The new control algorithm of RDE100.. family offers a choice of control actions that can be configured via parameter **P78**. This means that optimum control can be selected for every type of application (**factory setting "TPI slow"**).

### 2-position, 1 K

2-Position controller with 1 [K] switching hysteresis

### 2-position, 0.3 K

- 2-Position controller with 0.3 [K] switching hysteresis.
- For general control situations. Provides a better comfort than 1 [K] switching hysteresis.
- Can also be used for difficult control situations.

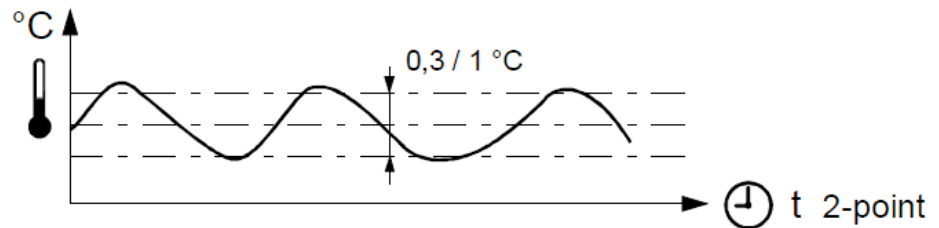

### TPI slow

TPI control behavior for slow heating systems that require longer minimum On times and limited numbers of switching cycles per hour.

Typical applications:

- Floor heating systems, oil fired boilers
- Can also be used for all other types of heating applications. (Alternative setting)

Minimum switching on / off time	> 4 minutes
Average period time	Approximately 20 minutes

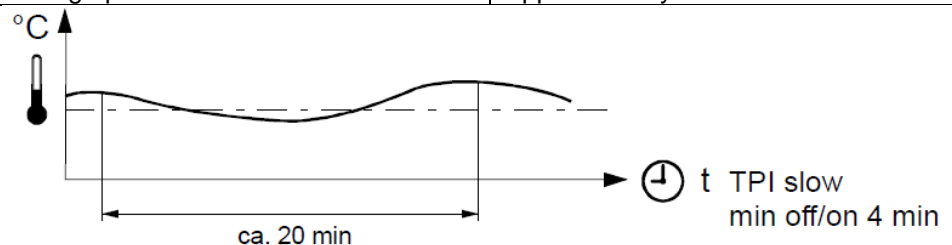

### TPI medium

TPI control behavior for general heating applications such as radiator systems, thermal actuators, ...

Minimum switching on / off time	> 1 minute
Average period time	Approximately 20-25 minutes

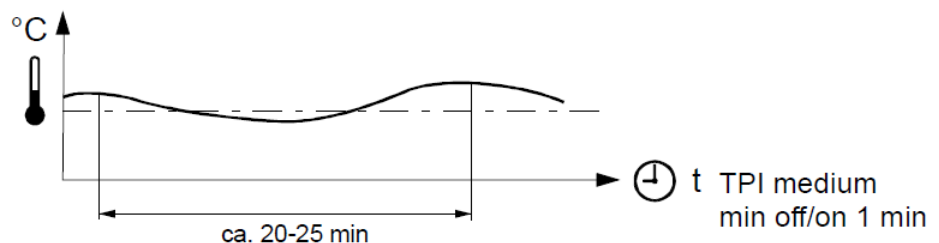

### TPI fast

TPI control behavior for fast heating systems that tolerate a high number of switching cycles.

Typical applications: electric heaters, gas boilers, fast thermal actuators

Minimum switching on / off time	> 1 minute
Average period time	Approximately 10 minutes

⚠ Do not use TPI fast for oil boilers or electro mechanical actuators!

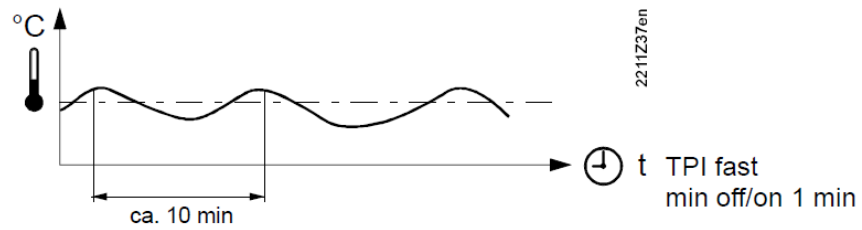

## Type summary

Product No.	Stock No.	Features
RDE100	<b>S55770-T278</b>	Mains-powered AC 230 V
RDE100.1	<b>S55770-T279</b>	Battery-powered DC 3 V









## Ordering

- When ordering, please indicate product No. / stock No. and description.
- Example:

Product No.	Stock No.	Description
RDE100	<b>S55770-T278</b>	Room thermostat

Valve actuators/external sensor must be ordered separately.

## Equipment combinations

Description		Product No.	Data Sheet *)	Use with the type of Temperature Control
Electromotoric actuator		<b>SFA21..</b>	4863	2-Position & TPI slow
Electrothermal actuator (for radiator valves)		<b>STA321</b>	A6V12986007	2-Position & All TPI
Electrothermal actuator (for small valves 2.5 mm)		<b>STP321</b>	A6V12986007	2-Position & All TPI
Damper actuator		<b>GDB..</b>	4634	2-Position & TPI slow
Damper actuator		<b>GSD..</b>	4603	2-Position & TPI slow
Damper actuator		<b>GQD..</b>	4604	2-Position & TPI slow
Rotary damper actuator		<b>GXD..</b>	4622	2-Position & TPI slow
Cable temperature sensor		<b>QAH11.1</b>	1840	N/A
Room temperature sensor		<b>QAA32 ..</b>	1747	N/A

\*) The documents can be downloaded from <http://siemens.com/bt/download>.

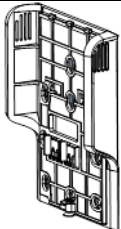
Description		Product No.	Mounting Instruction *)
Adapter plate (for China 86 conduit box, BS4662 UK conduit box)		<b>ARG70.5</b>	A6V10563479

\*) The documents can be downloaded from <http://siemens.com/bt/download>.

## Mechanical design

---

The room thermostat consists 2 parts:

- Plastic housing which accommodates the electronics, the operating elements and the room temperature sensor
- Mounting plate with screw terminals

The housing engages in the mounting plate and is secured with a screw.

## Operation and settings

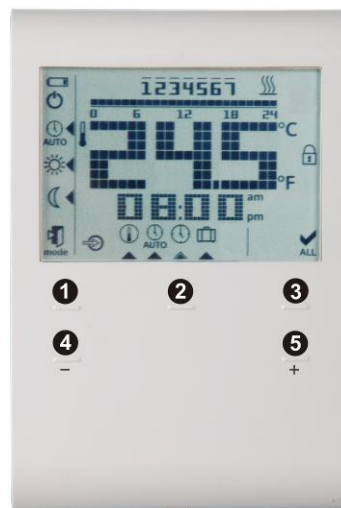

- 1) Operating mode touch key
- 2) Set
- 3) Ok
- 4) Touch key for decreasing a value
- 5) Touch key for increasing a value



## Display

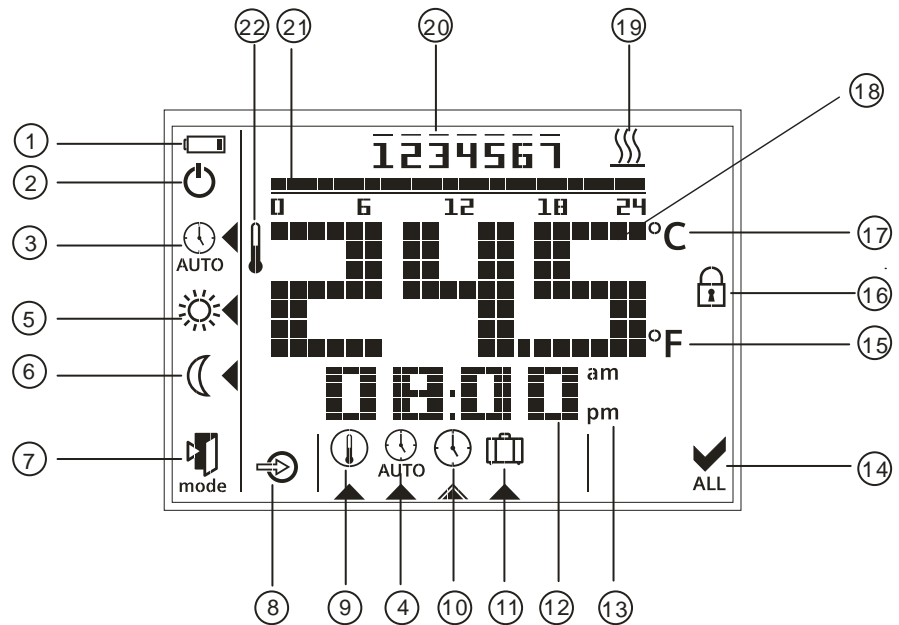

#	Symbol	Description	#	Symbol	Description
1		Indicating that batteries need to be replaced (only with battery-powered version RDE100.1)	12		Display of time
2		Protection mode (protection mode symbol can be enabled via parameter settings)	13	am pm	Morning: 12-hour format Afternoon: 12-hour format
3		Auto timer mode	14		Confirmation
4	AUTO	View and set auto time switch	15	°F	Room temperature in degrees Fahrenheit
5		Comfort mode	16		Touch key lock activated
6		Economy mode	17	°C	Room temperature in degrees Celsius
7		Escape	18		Display of room temperature, set point, etc.
8		External input enabled (RDE100.1 only)	19		Heating On
9		Permanent set point setting	20		Weekday 1 = Monday 7 = Sunday
10		Day and time setting	21		Timer bar
11		Holiday mode setting	22		Current room temperature

## Mounting and installation notes

Do not mount the thermostat in niches or bookshelves, not behind curtains, not above or near heat sources, and not exposed to direct solar radiation. Mount about 1.5 m above the floor.

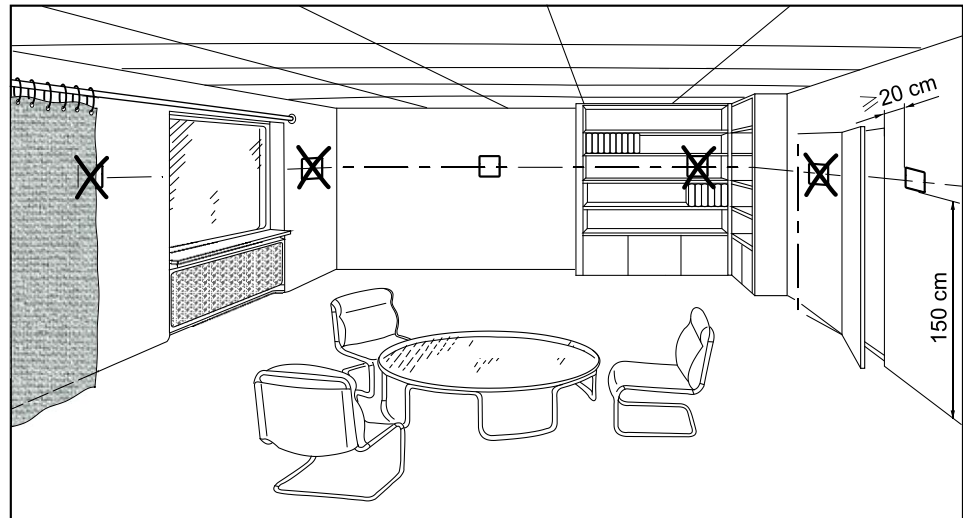

### Mounting



- Mount the thermostat in a clean and dry location without direct air flow from a heating/cooling equipment, and not exposed to drip or splash water  
Note: When RDE100.. is equipped with either China 86 conduit box or BS4662 UK conduit box, ARG70.5 adapter plate is suggested to provide a better fitting installation.

### Wiring

See Mounting Instructions M1429 enclosed with the thermostat.



- Ensure that wiring, protection and earthing comply with local regulations



- Correctly size the cables to the thermostat and the valve actuators



- Use only valve actuators rated for AC 24...230 V



#### **Warning!**

**No internal line protection for supply lines to external consumers.**

Risk of fire and injury due to short-circuits!



- Adapt the line diameters as per local regulations to the rated value of the installed overcurrent protection device



- The AC 230 V mains supply line must have a circuit breaker with a rated current of no more than 10 A



- Disconnect from power supply before removing the unit from its mounting plate



- External Inputs X1,  $\perp$  may carry mains potential. Sensor cables or window contact must carefully install before powering up the thermostat

## Commissioning notes

---

<b>Commissioning</b>	<p>After power is applied, the thermostat carries out a reset during which all LCD segments flash, indicating that the reset was made correctly. After the reset, the thermostat is ready for commissioning by qualified HVAC personnel.</p> <p>The control parameters of the thermostat can be set to ensure optimum performance of the entire system. Please refer to Operating Instructions CB1B1422, section "Do you want to change parameters?".</p>
<b>Sensor calibration</b>	<p>If the temperature on the display does not agree with the room temperature effectively measured, the temperature sensor can be recalibrated. For that purpose, adjust parameter P04.</p>
<b>Setpoint lock</b>	<p>We recommend reviewing the setpoint lock (for public areas) in parameters P06 and P08 and changing them as needed. If the Economy setpoint is locked then the Comfort temperature setpoint can not be set lower than the locked Economy setpoint.</p>
<b>Touchpad scanning rate</b>	<p>Since the thermostat uses touch technology and to minimize battery power consumption, a parameter P21 (adjustable from 0.25 to 1.5 seconds) is implemented for the user to adjust. This function is only valid for the battery-powered version and the default value is 1 second.</p> <p>This means that when, for a certain time, the user does not touch the touchpad, the unit operates in power saving mode and the touchpad is running at a scanning rate of 1 second.</p> <p>(From the calculation – assuming 4 operations per day on the thermostat, the estimated 1-second scanning rate results in a battery life of 1 year. If the user increases the scanning rate, the batteries' life is extended.)</p>
<b>X1 external input</b>	<p>Different parameter setting of X1 external input is described below:</p> <p>Parameter P14=0 (No Input) is a default setting, which provides no external input function.</p> <p><b>Digital input</b></p> <p>An external contact can switch the thermostat from any operating mode to Economy.</p> <p>Typical applications:   Window contact                                   Key card application</p> <p>Set parameter P14 = 2 (X1 External input = Digital Input) and adapt parameter P17 (Window contact = Normally Open / Closed) accordingly.</p> <p><b>External sensor (used for controlling)</b></p> <p>The measured external sensor temperature is displayed and used for calculating heating demand instead of temperature detected by thermostat built-in internal sensor. In case of problems with the external sensor, the thermostat uses the internal sensor instead.</p> <p>Typical applications:   External room temperature sensor                                   Floor heating temperature control bath room</p>

Setting parameter P14 = 1 (X1 External input = External Sensor) and parameter P15 = 0 (Temperature limitation = Off)

Notes for floor heating temperature control:

- External safety thermostat is needed to prevent overheating of certain floor heating systems!
- Use of "Comfort setpoint lock" function (Parameter P06) is recommended.
- In Protection mode, room temperature is acquired via internal temperature sensor not external temperature sensor.

### External sensor for Floor heating application with temperature limitation

Refer to Floor Heating application section above when setting parameter P14 = 1 (X1 External input = External Sensor) and parameter P15 = 1 (Temperature limitation = On). Parameter P16 now allows to limit the maximum temperature.

Note: In Protection mode, temperature limitation function is inactive.

### Change of batteries (only with battery-powered version RDE100.1)

If the battery symbol  appears, the batteries are almost exhausted and should be replaced. Use alkaline batteries type AAA.

### Operating notes

---

The RDE100.. provides Comfort, Economy, Auto timer and Protection mode. The difference between Comfort and Economy mode is only the room temperature setpoint. The changeover between Comfort, Economy and Protection mode is made either automatically by the auto time switch or by pressing touchkey **mode**.

#### Comfort mode

When Comfort mode is activated, symbol  appears on the display. The setpoint (20 °C) can be readjusted by pressing touchkeys + and -.

#### Economy mode

When Economy mode is activated, symbol  appears on the display. The setpoint (16 °C) can be readjusted by pressing touchkeys + and -.

In **RDE100.1**, a window contact feature is that a user can connect a window contact to the input X1, . Depending on whether the window contact is configured to Normally Open or Normally Close (Parameter P14 = 2, Parameter P17 = 0 or 1), a change in this status will automatically switch the thermostat from any modes to Economy mode. This feature is good for public area. The factory setting for this function is Off (disabled).

#### Protection mode

If the temperature falls below 5 °C, the unit automatically activates the heating output. The symbol  appears only, if the icon is enabled via parameter settings.

#### Time switch

When Auto timer mode is enabled, the changeover between the operating modes (Comfort and Economy mode) will take place automatically. There are three options for time switch setting: individual day, 7 day or 5-2 day. You can select Comfort or Economy mode in every 15 minutes interval of the day. The 0:00 to 24:00 hour time bar will allow you to set the mode throughout the selected day(s).

Default value	Day/s	Comfort mode	Economy mode
	Mo (1) – Fr (5)	6:00 – 8:00 hr 17:00 – 22:00 hr	22:00 – 6:00 hr 8:00 – 17:00 hr
	Sa (6) – Su (7)	7:00 – 22:00 hr	22:00 – 7:00 hr

Please refer to Operating Instructions CB1B1422, section "Do you want to enter your own time switch?"

## Holiday mode

When holiday mode is activated, symbol  appears on the display. The set point (12 °C) and the number of days a user is away can be readjusted by pressing touch keys + and –.

## Parameters

Changing the parameters by the following steps:

- Press + and – simultaneously for 5 seconds
- Release them and parameter "P01" is displayed on the bottom segment
- Press + or – to scroll to the parameter that needs to be adjusted
- Press **ok** to select this parameter
- Press + or – to adjust the value
- Press **ok** to confirm the adjusted value
- Press mode to exit the parameters without saving or wait for the program to exit automatically

## Parameter list

Parameter no.	Description	Setting range (default)
P01	Time format	1 = 24:00 hours (default) 2 = 12:00 AM/PM
P02	Selection of °C or °F	1 = °C (default) 2 = °F
P03	Standard temperature display	1 = room temperature (default) 2 = setpoint
P04	Temperature sensor calibration	-3...3 °C Step 0.5 °C (-6...6 °F, step 1 °F) Default: 0 °C
P06	Comfort setpoint lock	0 = OFF (default) 1 = ON → locked according to setting in permanent temperature setpoint
P08	Economy setpoint lock	0 = OFF (default) 1 = ON → locked according to setting in permanent temperature setpoint
P09	Buzzer	0 = OFF 1 = ON (default)
P10	Show frost protection icon	0 = OFF (default) 1 = ON
P11	Time switch type for auto timer	0 = Individual Days (default) 1 = All 7 days 2 = 5/2 days
P12 *	Periodic pump run	0 = OFF (default) 1 = ON

P14	X1 External input (only for RDE100.1)	0 = No input 1 = External sensor 2 = Digital Input
P15	Temperature limitation (only for RDE100.1)	0 = OFF (default) 1 = ON
P16	Max limitation temperature for underfloor heating (only for RDE100.1)	25...60 °C, step 1 °C or 77...140 °F, step 1 °F Default: 30 °C
P17	Window contact features (only for RDE 100.1)	0 = Normally Open Contact (default) 1 = Normally Closed Contact
P21	Button scanning rate for the capacitive buttons (RDE100.1 only) Note: a shorter scanning rate means shorter battery life.	0.2 = 0.25 s 0.5 = 0.5 s 1.0 = 1.0 s (default) 1.5 = 1.5 s
P22	Reload factory settings	0 = OFF (default) 1 = reload
P23	Software version information	No adjustment possible
P78	Control behavior	0 = On/Off, 1.0 K 1 = On/Off, 0.3 K 2 = TPI fast 3 = TPI medium 4 = TPI slow (default)
P89	Forward shift on max	0, 0.5,...24 h Default: 0 h
P90	Early shutdown max	0, 0.5,...6 h Default: 0 h

Note:

\* P12 is visible only when P10 = 0.

## Maintenance notes

---

The thermostats are maintenance-free.

## Disposal

---



This symbol or any other national label indicate that the product, its packaging, and, where applicable, any batteries may not be disposed of as domestic waste. Delete all personal data and dispose of the item(s) at separate collection and recycling facilities in accordance with local and national legislation. For additional details, refer to [www.siemens.com/bt/disposal](http://www.siemens.com/bt/disposal).

	<b>⚠ WARNING</b>
	<b>Risk of explosion due to fire or short-circuit, even if the batteries are empty</b> Risk of injuries from by flying parts <ul style="list-style-type: none"><li>• Do not allow the batteries to come into contact with water.</li><li>• Do not charge the batteries.</li><li>• Do not damage or destroy the batteries.</li><li>• Do not heat the batteries to more than 85 °C.</li></ul>

	<b>⚠ WARNING</b>
	<b>Electrolyte leakage</b> Chemical burns <ul style="list-style-type: none"><li>• Only grasp damaged batteries using suitable protective gloves.</li><li>• If electrolyte comes into contact with eyes, immediately rinse eyes with plenty of water. Consult a doctor.</li></ul>

Observe the following:



- Only replace batteries with batteries of the same type and from the same manufacturer.
- Observe the polarities (+/-).
- The batteries must be new and free from damage.
- Do not mixed new batteries with used batteries.
- Store, transport, and dispose of the batteries in accordance with local regulations, guidelines, and laws. Also observe information from the battery manufacturer.

## Warranty

---

The technical data given for these applications is valid only in conjunction with the Siemens actuators as detailed under «Equipment combinations», page 4. Use with third-party actuators invalidates any warranty offered by Siemens Building Technologies HVAC Products.

## Technical data

 Power supply	Operating voltage	
	<ul style="list-style-type: none"> <li>RDE100 at L - N</li> </ul>	AC 230 V +10/-15%
	Frequency	50 Hz
	Power consumption	8.5 VA / 1 W
	<ul style="list-style-type: none"> <li>RDE100.1</li> </ul>	DC 3 V (2 x 1.5 V alkaline batteries AAA)
	For battery life (RDE100.1), see below (alkaline batteries type AAA). Battery life calculation is based on the touchpad scanning rate during idle time (assuming a user presses 4 touch keys per day with default TPI Slow control):	
	Scanning rate 0.25 s	0.7 year battery life
	Scanning rate 0.50 s	1.0 year battery life
	Scanning rate 1.00 s	1.2 year battery life
	Scanning rate 1.50 s	1.3 year battery life
Control inputs	Control input Q11-Nx (Com)	
	<ul style="list-style-type: none"> <li>Rating RDE100</li> </ul>	(AC 24...230 V) Max. 5(2) A Min. 8 mA
	<ul style="list-style-type: none"> <li>Rating RDE100.1</li> </ul>	(AC 24...230 V) Max. 5(2) A Min. 8 mA
External sensor (RDE100.1 only)	External sensor	
	'X1' - '⊥' (Reference)	NTC3K/QAH11.1/QAA32
	Or	
	Digital On/Off	
	'X1' - '⊥' (Reference)	On/Off switch
Control outputs	Control output Q12-Nx (NC contact)	
	Rating RDE100	(AC 24...230 V) Max. 5(2) A Min. 8 mA
	Rating RDE100.1	(AC 24...230 V) Max. 5(2) A Min. 8 mA
	Control output Q14-Nx (NO contact)	
	Rating RDE100	(AC 24...230 V) Max. 5(2) A Min. 8 mA
	Rating RDE100.1	(AC 24...230 V) Max. 5(2) A Min. 8 mA
	<b>No internal fuse.</b>	
	External preliminary protection with max. C 10 A circuit breaker in the supply lines required under all circumstances.	
	External protection for incoming cable	
	Circuit breaker	Max. 10 A
	Circuit breaker tripping characteristic	Type B, C or D to EN 60898 and EN 60947
Function data	Comfort mode	20 °C (5...35 °C)
	Economy mode	16 °C (5...35 °C)
	Holiday mode	12 °C (5...35 °C) (Standalone)
	Built-in room temperature sensor	
	Setpoint setting range	5...35 °C (Comfort/Economy mode)
	Accuracy at 25 °C	< ±0.5 K
	Temperature calibration range	±3.0 K
	Resolution of settings and displays	
	Setpoints	0.5 °C
	Temperature value displays	0.5 °C



Environmental conditions	Operation	As per IEC 60721-3-3	
	Climatic conditions	Class 3K5	
	Temperature	0...50 °C	
	Humidity	<95% r.h.	
	Transport	As per IEC 60721-3-2	
	Climatic conditions	Class 2K3	
	Temperature	-25...65 °C	
	Humidity	<95% r.h.	
	Mechanical conditions	Class 2M2	
	Storage	As per IEC 60721-3-1	
	Climatic conditions	Class 1K3	
	Temperature	-25...65 °C	
Humidity	<95% r.h.		
Norms and standards	EU Conformity (CE)	A6V11399487 *)	
	RCM conformity	A6V11399489 *)	
	Safety class	II as per EN 60730-1, EN 60730-2-9	
	Pollution class	II as per EN 60730-1	
	Degree of protection of housing	IP30 as per EN 60529	
Environmental compatibility	The product environmental declaration CE1E1420xx *) contains data on environmentally compatible product design and assessments (RoHS compliance, materials composition, packaging, environmental benefit, disposal).		
	Meets the requirements for eu.bac certification as per EN 15500-1 See product list at: <a href="http://www.eubaccert.eu/licences-by-criteria.asp">http://www.eubaccert.eu/licences-by-criteria.asp</a>		
eu.bac 	RDE100.1 (license 221177)	Control accuracy [K]	
	Water Heating System (thermal actuator, On/Off)	0.4	
	Water Floor Heating Systems (thermal actuator, On/Off)	0.3	
Eco design and labelling directives	Based on EU Regulation 813/2013 (Eco design directive) and 811/2013 (Labelling directive) concerning space heaters, combination heaters, the following classes apply:		
	- Application with On/Off operation Class I of a heater	value 1%	
	- TPI (PWM) room thermostat, for use with On/Off output heaters	Class IV value 2%	
General	Connection terminals for	Solid wires or prepared stranded wires 2 x 1.5 mm <sup>2</sup> or 1 x 2.5 mm <sup>2</sup> (Min. 0.5 mm <sup>2</sup> )	
	Weight	0.166 kg	
	Color of housing front	RAL9003	

\*) The documents can be downloaded from <http://siemens.com/bt/download>.

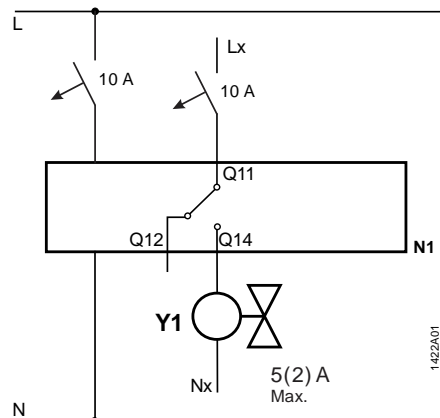

1422A01

**RDE100**

- N1 Room thermostat
- Y1 Valve actuator
- L Live, AC 230 V
- N Neutral conductor, AC 230 V

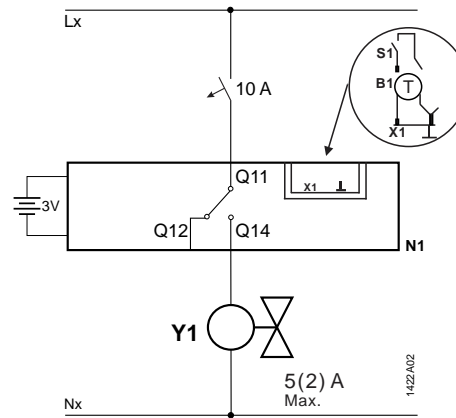

1422A02

**RDE100.1**

- Lx Live, AC 24 ... 230 V
- Q11, Q12 NC contact (for NO valves)
- Q11, Q14 NO contact (for NC valves)
- Nx Neutral conductor, AC 24...230 V
- X1 External input signal
- ⊥ Measuring neutral for external input
- B1 Temperature sensor (Floor temperature limit)
- S1 Switch (keycard, window contact)

## Application examples

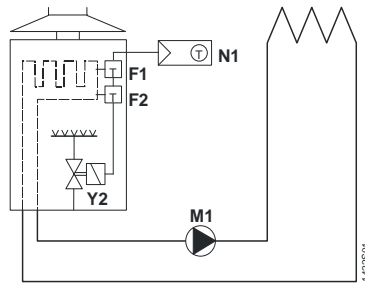

Room thermostat with direct control of a gas-fired wall-hung boiler

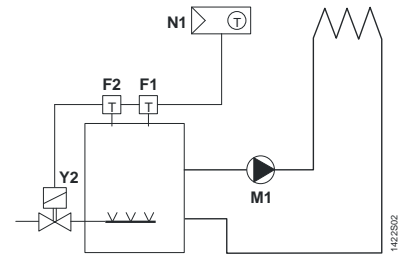

Room thermostat with direct control of a gas-fired floor-standing boiler

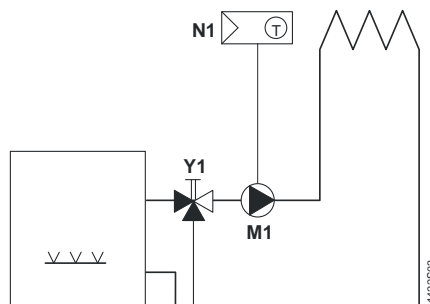

Room thermostat with direct control of a heating circuit pump (precontrol by manual mixing valve)

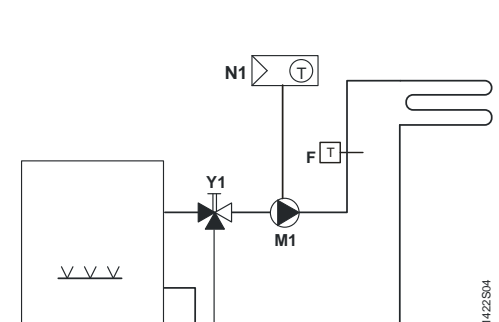

Room thermostat with direct control of hydronic floor heating system

F1 Thermal reset limit thermostat  
 F2 Safety limit thermostat  
 M1 Circulating pump

N1 RDE100.. room thermostat  
 Y1 Mixing 3-port valve with manual adjustment  
 Y2 Magnetic valve

## Remarks

### Heating:

Because of the unavoidable self heating effects of the electrical current, any loads of more than 3 Amperes connected to the unit can influence the control behavior and temperature accuracy in a negative way.

## Dimensions

All dimensions in mm

