



Web Server

For LPB/BSB plants

OZW672.. V12.0

Web server OZW672.. allows for remote plant control and monitoring via the web and Smartphone-App. Web server is available in three versions: To connect 1 LPB/BSB unit or 4 or 16 LPB units for the Sigmagyr / Albatros and Albatros2 ranges.

- Operate via web browser with PC/laptop and Smartphone
- Operate via Smartphone app (iPhone and Android)
- Operation via the Climatix IC / Synco IC Internet portal with auxiliary functions
- Plant visualization in the web browser based on customized plant web pages
- Gateway for remote operation of the M-bus web server WTV676-HB6035 via Climatix IC / Synco IC
- Display fault messages in the web browser
- Send fault messages to a maximum of 4 e-mail recipients
- Periodically send system reports to maximum of 4 e-mail recipients
- Create trends, trend graphs and send trend data to 2 e-mail recipients or to the FTP server
- Function "Energy indicator" to monitor data points for energy-related limit values, or "Green limits" and send to 2 e-mail recipients

- **Web services for external applications via Web API (Web Application Programming Interface)**
- **Encrypted with https and TLS V1.3 for emails (all connections)**
- **ACS790 functionality**
- **Secure tunnel connection for ACS via Climatix IC / Synco IC portal**
- **Time sync via NTP network time server**

Use

Buildings

- Apartments in single and multi-family homes.
- Office and administrative buildings, residential housing.
- Schools, gymnasiums, leisure facilities, hotels.
- Municipal buildings, commercial and smaller industrial buildings.

Owners/operators

- End customers, HVAC and electrical installers, heating manufacturers.
- Real estate agencies, real estate management companies, service organizations.
- Building maintenance companies, facility management.

Functions

Commissioning

Commissioning is carried out via PC/Laptop and Web browser and as an option with ACS.

A quick commissioning mode is available on plants with only a single connected controller.

Web operation

- Remotely operate and monitor plants and devices on a LPB/BSB network using a web browser on PC/laptop and Smartphone.
- Access via Climatix IC / Synco IC Internet portal or direct connection
- Simultaneous support of multiple users.
- User accounts for web operation (user groups, operating language).
- Set up customized plant web page features.

Access via Climatix IC / Synco IC

Siemens offers with the Climatix IC / Synco IC Internet portal simple and secure access to web servers (available as of web server version 5.2).

Benefits

- Simple and fast set up of access via the Internet – neither a fixed IP address, nor forwarding of a dynamic IP address, nor port forwarding (NAT/PAT) is required
- The portal provides additional functions:
 - Manage one or multiple plants
 - Central user management
 - Display of plant overview, state of Energy indicators, and alarms
 - Plant functional scope can be set for various plant roles
 - Logging fault messages as common faults
 - Send alarm notifications per e-mail
 - Secured communications through encryption (https)

Access to Climatix IC / Synco IC via OZW gateway

Web server OZW672.. can also be used as a gateway for remote operation of the M-bus web server WTV676-HB6035 in Climatix IC or Synco IC. Before accessing the M-bus web server, you must register in Climatix IC or Synco IC and configure and activate the OZW gateway. You can no longer access the OZW web page via the portal once the OZW gateway is activated.

Benefits

- Remote operation of the M-bus web server anywhere at any time
- Central management of multiple plants (M-bus web server and OZW) over a common account in Climatix IC or Synco IC
- Direct access to the web view of the M-bus web server and the OZW over the portal

Access without Climatix IC- / Synco IC- Internet portal (direct connection)

Direct access to the web server is possible via USB or Ethernet (without Climatix IC or Synco IC).

A direct connection in parallel to the Climatix IC or Synco IC portal is possible.

Direct Internet access (Climatix IC, Synco IC)

A connection (e.g. DSL router) is required to connect directly via the Internet. The web server is not suitable for connecting directly to the Internet since it does not have a firewall; normally a component of the DSL router.

Port forwarding must be configured on the router to connect directly to the Internet. We recommend against this, since this opens up the firewall.

For security reasons (data protection), we recommend using the Synco IC portal.

The secure tunnel connection used with the Synco IC portal is more secure than a direct connection.



Set up a VPN as a secure alternative.

Web user interface

The web server user interface is the same as when using the Climatix IC or Synco IC Internet portals and when connected directly to Climatix IC or Synco IC also includes additional functions and settings.







User interface
web server
(Direct connection)

SIEMENS



09.01.2018 12:26  

Home Energy indicator Faults File transfer User accounts Device web pages  [Logout] Administrator

Home > 0.6 OZW672.16 > Settings > Communication > Ethernet

Datapoint	Value
DHCP client	On 
IP address	192.168.2.43
Subnet mask	255.255.255.0
Default gateway	192.168.2.1
Preferred DNS server	192.168.2.1
Alternate DNS server	
Set when DHCP client off	
IP address	192.168.2.10 
Subnet mask	255.255.255.0 
Default gateway	192.168.2.1 
Preferred DNS server	192.168.2.1 
Alternate DNS server	
Physical address	00:a0:03:fd:27:f0





In the web server user interface, the user symbol  and user name is displayed in place of the Climatix IC or Synco IC portal symbol .

User interface portal Climatix IC, Synco IC

The screenshot displays the Siemens web server user interface. At the top, there is a navigation bar with 'Dashboards', 'Operating', and 'Administration' tabs. The 'Operating' tab is active, showing a breadcrumb trail: 'Operating > O.Z.W. Retail GmbH. (zählerweg 3, Zug, LPB, BSB, English) > Web access'. The main content area is titled 'SIEMENS' and shows the date '09.01.2018' and time '12:25'. Below this is a navigation menu with 'Home', 'Energy indicator', 'Faults', 'File transfer', 'User accounts', and 'Device web pages'. The 'Device web pages' menu item is selected, leading to a page titled 'Home > 0.6 OZW672.16 > Settings > Communication > Ethernet'. The page contains a table of network settings for the Ethernet interface.

Datapoint	Value
DHCP client	On
IP address	192.168.2.43
Subnet mask	255.255.255.0
Default gateway	192.168.2.1
Preferred DNS server	192.168.2.1
Alternate DNS server	
Set when DHCP client off	
IP address	192.168.2.10
Subnet mask	255.255.255.0
Default gateway	192.168.2.1
Preferred DNS server	192.168.2.1
Alternate DNS server	

Click the symbol  to open the web server user interface under a new tab and is then the same as the view under a direct connection.

The Climatix IC or Synco IC portal symbol  and e-mail address is displayed in place of the user symbol  and user name.

Primary navigation

Primary navigation offers the following functions:

Home	Menu-based plant and device operation.
Energy indicator	Display and operate "Energy indicator" data points. (displayed only if a controller is connected with an Energy indicator)
Faults	Display system faults.
File transfer	Create and manage trend functions Download consumption data and event history, Upload documents, logos and system definitions as well as firmware update.
User accounts	User administration.
Device web pages	Create device list and operating pages.

Secondary navigation

The secondary navigation (menu tree) allows users to select devices and operating pages.

Display

The display range displays content corresponding to the selected primary and secondary navigation.

Plant state

The display indicates no fault or the most serious plant fault depending on plant state.

Faults

Fault sources

The web server recognizes failures and fault signals from LPB/BSB devices contained in the device list. Faults from digital inputs and own faults are detected also.

Fault indication

The LED  signals a fault on the web server. The LED is lit for as long as the fault is present.

Fault status message

Fault status messages can be sent as an e-mail to as many as 4 e-mail recipients and/or via a service provider to SMS recipients. You can set the fault priority for each email recipient (urgent/all). Each receiver has a "Time switch with calendar" to program three sending times per day and holidays/special days.

Common fault

On the Climatix IC/Synco IC Internet portal, faults are logged as common faults. The portal sends alarm notifications to the defined e-mail addresses in the event of a common fault.

System report

System messages The web server generates system reports and periodically sends the system state to e-mail recipients. Messages are sent as per the set time (hh:mm), the message cycle interval (1...255 days), and priority (urgent/non-urgent).

Connection test Press the ✓ button on the web server to send a system report to all defined email recipients regardless of fault priority.

History The last 500 fault events, fault messages and system reports are entered in the web server's circular message buffer. The events or history data can be read via web browser.

Time The web server has a system clock with adjustable daylight saving/standard time changeover. It can send the time (date and time) as the time clock master to the LPB devices (time clock slave).
For the system clock, the NTP network time server can perform the time synchronization and, if used as a time clock master, forward the data to all KNX devices (time clock slaves).

Updates We differentiate between the following:

- System definition updates to integrate device descriptions of new devices in the web server.
- Firmware updates to update the web server to the latest firmware version. The user settings and system definitions remain as part of a firmware update.
- Factory update to the web server to the latest version and load the latest system definitions. User settings are lost as part of a factory update.

A system definition update and the firmware update requires one simple action via the web browser.
Operator actions on the web server are required for the factory update. Procedures are communicated when a factory update is issued.

ACS790 The web server is compatible with the service and operating software ACS790 version 10.00 and higher.

Secured connection via Climatix IC / Synco IC On web servers as of V7.0, you can establish a secure connection to the web server with the ACS790 and the "Remote Tool Access" software via the Climatix IC / Synco IC portal.

Visualize plants

Web server OZW672.. allows for visualizing technical equipment in buildings via plant web pages. For example, a plant web page can be set up visualizing a plant with data points (max. 100 data points per plant web page) on a floor plan.

In the event of a fault, users can quickly access the impacted locations.

For writable parameters, users can click to open a dialog box and change the parameter (as e.g. the "Room temp reduced setpoint" displayed below).

Example Plant web page for heating plant

Import plant diagrams

For standard LPB/BSB controller applications, web-capable plant diagrams can be exported from ACS790 and imported in the web server.

Create own plant web pages

You can freely design plant web pages. As a hybrid form, you can also modify and extend downloaded plant diagrams.

Web page elements

Users can also embed additional data in a plant diagram such as links to plant, function and maintenance descriptions or data sheets. Moreover, users can integrate external links allowing, for example, to directly browse multiple plants. Users can embed current webcam images in a plant diagram.

Trend function The trend function in Web-Server OZW672.. can be directly defined on Web server version 5.0.
Using the trend functions, you can log and query any number of data points from connected devices as a selectable sample rate.

Trend channels 5 trend channels are available. Each trend channel can contain up to 100 data points. The trend channel can be labeled using a free text name.

Sample rate The sample rate can be individually created for each trend channel. Available sample rates ranging from 1 s up to 24 hours.
The shortest possible sample rate over all 5 trend channels is 1 data point per second.

Trend period RAM size determines possible trend periods for a channel. The trend period varies with the number of selected data points and their sample rates.

Examples for various trend channels:

Interval	Data points	Trend period	
		Channel 1	Channel 2...5
1 sec	1	14 days	1.8 days
5 sec	5	30 days	4.3 days
1 min	10	210 days	30 days
15 min	100	371 days	53 days

Trend channel 1 has 7 times the available memory for long-term trends or trends with a lot of data points or a short sample interval.

Synchronization Trends are synchronized to simplify evaluation of trend data. The various query intervals for the trends are placed on an interval grid.

Operation The web browser or ACS tool is used to create and manage trend functions.

The screenshot shows the Siemens OZW672.01 web interface. At the top, there is a navigation bar with the Siemens logo, the device ID 'OZW672.01', the date '31.01.2018', and the time '14:27'. Below the navigation bar, there are several tabs: Home, Energy indicator, Faults, File transfer, User accounts, and Device web pages. The 'Trend' tab is selected, showing a list of trend functions. The list has columns for Name, State, Query interval, Circular logging, Bus load, and Action. The following table represents the data shown in the screenshot:

Name	State	Query interval	Circular logging	Bus load	Action
Outside temperature	Running	2m	>730 Days	1 %	[Action]
Roomtemp setpoint	Running	5m	728 Days	0 %	[Action]
Room temperature	Running	5m	728 Days	0 %	[Action]
DHW setpoint	Running	10m	>730 Days	0 %	[Action]
DHW temperature	Running	10m	>730 Days	0 %	[Action]

At the bottom of the screenshot, there is a progress bar showing '2%' and the text 'Current bus load'.

Data query per web browser

A web browser allows you to download trend data for each channel and view it in a spreadsheet program or text editor. A calendar function allows limiting trend data to the desired period within trending.

Web server can be accessed directly or via the Internet.

Trend graph

Data for a trend channel can be graphically displayed on the web user interface. The function is available for OZW672... as of version 6.0.

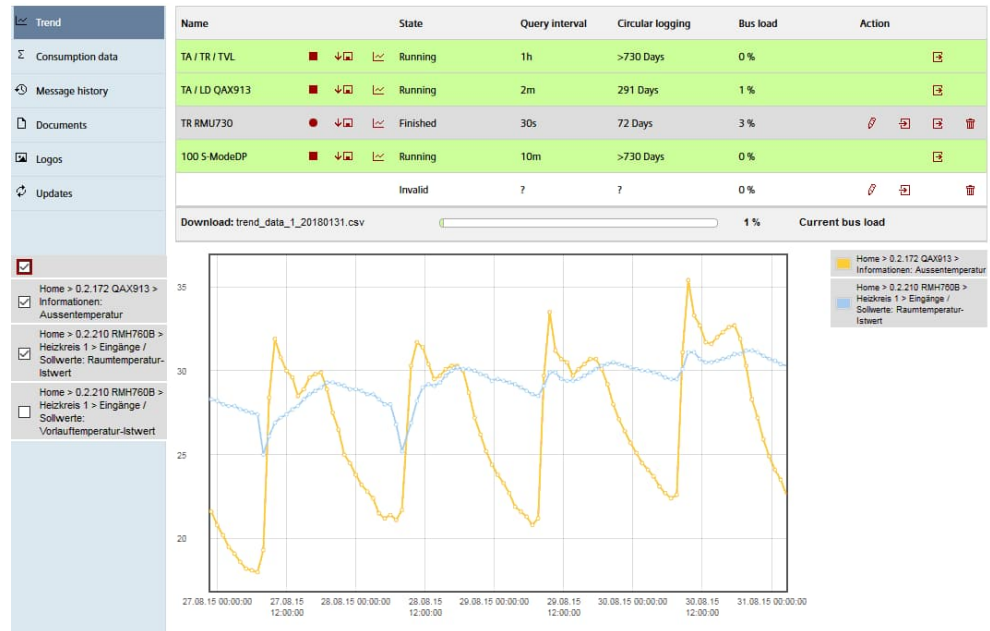

Data transmission per e-mail

2 e-mail recipients can be defined for trend data. Each trend channel can send its data to one or both e-mail recipients.

The send interval can be individually set for each trend channel.

Import/export

Trend definitions can be imported to web server or exported from the web server.

Function "Energy indicator"

Function "Energy indicator" is available on the OZW672.. web server from V4.0.

The web server uses the "Energy indicator" function to read selected data point values from the LPB and BSB bus devices and to compare the values to energy-related limit values, or so-called "Green limits".

The data points are also monitored for adherence to the "Green limits". As a result, the "Energy indicator" is displayed in the form of a tree leaf.

Note

The "Green limits" are used only together with the "Energy indicator" function. They do **not** represent process or safety limit values which trigger e.g. fault messages or turn off the plant in the event of limit violations.

Web server, e-mail

The "Energy indicator" can regularly send its information (set via the web server) to a maximum of 2 e-mail recipients.

Tree leaf as "Energy indicator"

Green leaf 

"Green leaf" → Green tree leaf, leaf pointing up.

- The "Green leaf" symbol indicates that a data point value has not exceeded its "Green limit", i.e. the value is within a "green" range in terms of energy consumption.

Orange leaf 

"Orange leaf" → Orange tree leaf, leaf pointing down.

- The "Orange leaf" symbol indicates that a data point value has exceeded its "Green limit", i.e. the value is outside a "green" range in terms of energy consumption.

Standard EN 15232



The "Energy indicator" function is based on standard EN 15232 "Energy efficiency in buildings".

Example: Web page "Energy indicator"

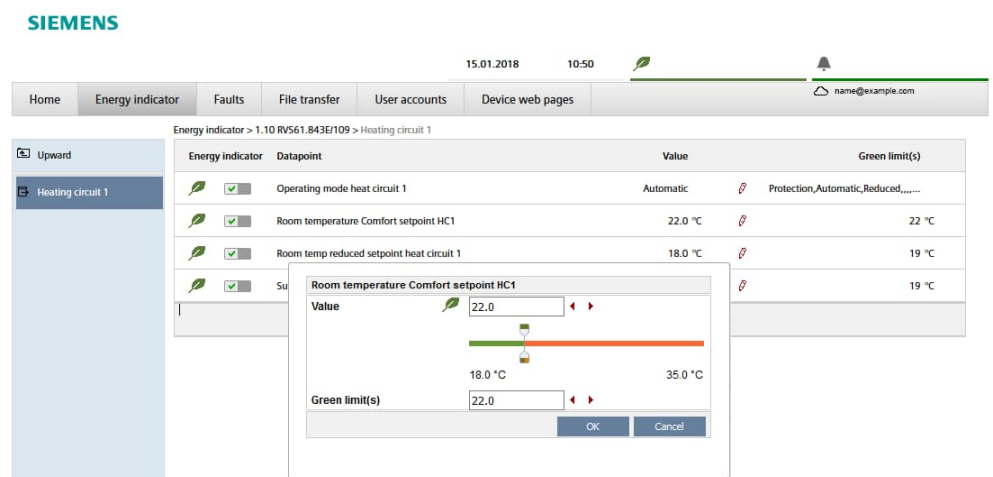
Web page with "Energy indicator" function; example with data points from "Heat circuit 1" and open dialog box to set data point value "Room temperature Comfort setpoint HC 1" and its "Green limit".







SIEMENS

15.01.2018 10:50  

Home Energy indicator Faults File transfer User accounts Device web pages name@example.com

Energy indicator > 1.10 RV561.843E109 > Heating circuit 1

Energy indicator	Datapoint	Value	Green limit(s)
	<input checked="" type="checkbox"/> Operating mode heat circuit 1	Automatic	Protection, Automatic, Reduced,
	<input checked="" type="checkbox"/> Room temperature Comfort setpoint HC1	22.0 °C	22 °C
	<input checked="" type="checkbox"/> Room temp reduced setpoint heat circuit 1	18.0 °C	19 °C
	<input checked="" type="checkbox"/> Su		19 °C

Room temperature Comfort setpoint HC1

Value  22.0

18.0 °C 35.0 °C

Green limit(s) 22.0

OK Cancel

Web services

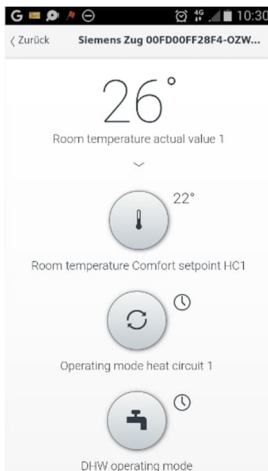

The "Web Application Programming Interface" (Web API) is an interface to make web services on a web server accessible to clients.

All Web API functions are called up via "http" or encrypted "https". Each session begins with authentication on the web server.

If the "HomeControl IC" App installed on a smart phone, the web services can access the data points of the devices on the LPB network via the Web API (communication connection for smart phone see page 11).

FTP server

Trend and consumption data can be regularly sent to a FTP server. The interval can be adjusted.

The following transmission protocols are supported:

FTP	File Transfer Protocol	Unencrypted and therefore not recommended
FTPS	FTP over TLS	TLS encrypted communication with the FTP server
SFTP	SSH File Transfer Protocol	FTP tunneling via a SSH (Secure Shell) connection

Type summary

Name		Product number
Web server	for 1 LPB/BSB device	OZW672.01
Web server	for 4 LPB devices	OZW672.04
Web server	for 16 LPB devices	OZW672.16

Ordering and delivery

When ordering, please specify the name and **product number**.

Example: Web server **OZW672.16**

The web server is delivered in a cardboard box.

The following is included in the package:

- Mounting instructions M5712xx.
- Power cable, power supply AC 230 V.
- Ethernet cable.
- USB cable.
- 2 cable ties.

Equipment combinations

LPB/BSB devices

The following devices from the Sigmagr/Albatros product range can be connected to each OZW672.. web server via LPB/BSB.

- Heating controllers RVL4.., RVP3..
- District heating controller RVD2..
- Universal controller RVP5..
- Heating controllers RVA.., RVS.., RVC..
- Boiler management units LMU.., LMS..

Note

Download a detailed list of compatibility of LPB/BSB devices from <https://support.industry.siemens.com/cs/ww/en/view/62567396>.

Product documentation

	Document type	Document no.
Web server OZW672..	Data sheet (this document)	N5712
	Mounting instructions (package insert)	M5712
	Installation instructions	G5711
	Commissioning instructions	C5712
	CE declaration of conformity	T5711
	Environmental product declaration	E5711
ACS790 software	Data sheet	N5649

Technical design

Web browser

Devices	Demand
PC/Laptop (1024 x 786)	html5 compatible web browser
Smart phone	Specific to the particular end device

Concurrent operation

Concurrent operation is unlimited. The maximum data throughput is shared between the users. Operation slows down as the number of users increases accordingly.

Operation, monitoring, alarming

Communication connections for local commissioning (USB) and remote operation, remote monitoring and alarming via Ethernet.

The web server is not suited for direct connection to the Internet, but rather must be connected via a firewall. A router typically includes a firewall.

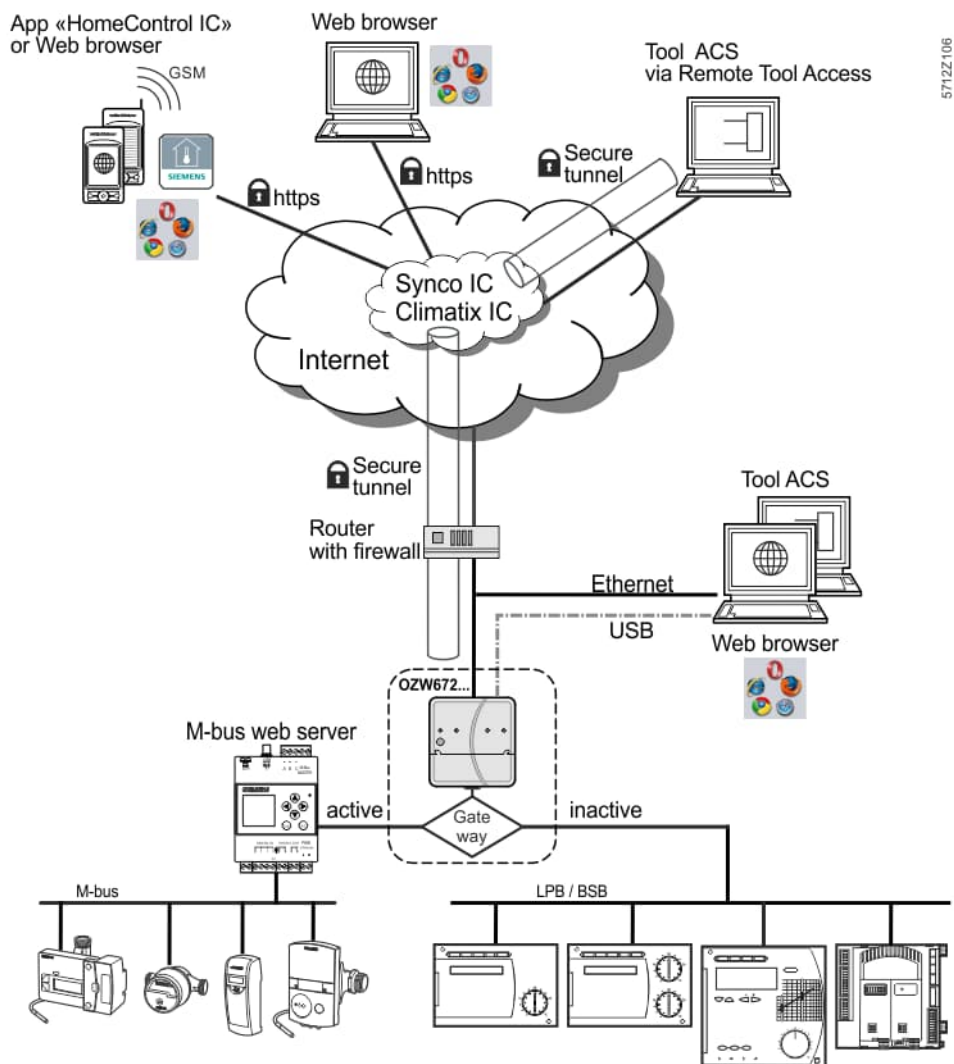

Web server OZW672.. can also be used as a gateway for remote operation of the M-Bus web server WTV676-HB6035. Once the gateway is active, you can access the web page of the M-bus web server via Climatix IC or Synco IC. You can no longer access the OZW web server once the gateway is activated. The OZW web server web page displays if the gateway is inactive.

Interfaces

USB	The USB interface directly connects the PC/laptop on site. The required USB cable type A – type Mini-B is delivered with the device.
Ethernet	The router/network is connected to the Ethernet RJ45 plug. The Ethernet interface features Auto-MDI(X) for crossed and non-crossed Ethernet cables. An Ethernet category 5 cable is supplied.
LPB/BSB	The LPB/BSB bus is connected to terminals DB/CL+ and MB/CL- . For information on the LPB/BSB bus, see Local Process Bus System Engineering, basic documentation P2370.
Digital inputs	The digital inputs D1, D2 help connect potential-free status contacts. They work as fault inputs.

Protocols

Web operation	<p>Web operation via portal takes place through an HTTPS encrypted connection (Port 443) via TCP/IP. The required certificate is accredited.</p> <p>Web operation without portal takes place through an HTTPS encrypted connection (Port 443) via TCP/IP. The required certificate is not accredited. The self signed certificate by Siemens is saved to the web server and cannot be changed.</p> <p>In addition, an HTTP (Port 80) connection is supported. Port 80 is disabled as delivered. The access via http is not secured. The user is responsible for enabling Port 80.</p> <p>A RNDIS driver on the PC/laptop is required for USB communication. The RNDIS driver is already included in the Windows operating systems for web server as of version 7.0.</p>
Send email	Fault messages and "Energy indicator" reports and trend files are sent in an email via SMTP. The email is encrypted using TLS V1.3 if supported by the mail server.
DHCP client	The web server can be manually configured or take over its network configuration as a client of a DHCP server.

Design

The web server consists of the housing lower section with printed circuit boards and interfaces as well as connection terminals. The upper housing section contains the printed circuit boards. The upper housing section contains the LED displays and one operating button. The connection terminals and additional display and operating elements are located under the removable cover for the upper housing section. All display and operating elements are labeled.

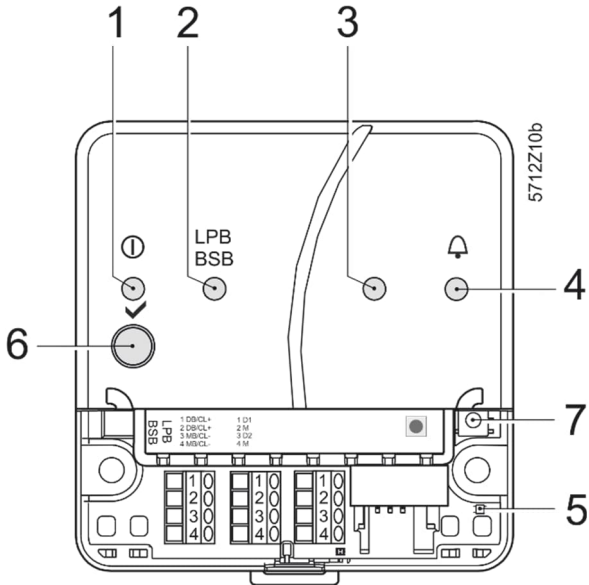

Pos	Element	Designation
1	⓪ LED (red / green / orange)	On-LED Operation, portal connection display and "Energy indicator"
2	LED (green)	LPB/BSB
3	LED	No function
4	⚠ LED (red)	Fault LED
5	LED (red / green)	Quick commissioning LED
6	✓ Button	Remote button
7	⊙ Button	Service button

LED indicators

1 ⓪ (red/green/orange)	• Off	No power
	• Red on	Web server is starting the operating system
	• Flashing red	Web server starting the application
	• Green on	Web server operational, Energy indicator = Green leaf
	• Orange on	Web server operational, Energy indicator = Orange leaf
	• Flashing green / orange	Web server operational, connected to the portal (LED 0.8 s on, 0.2 s off)
2 LPB/BSB (green)	• Off	No bus power
	• On	LPB/BSB operational
	• Blinking	Communication on LPB/BSB
3 (LED)		No function
4 Faults ⚠ (red)	• Off	No fault (normal operating state)
	• On	Fault
5 Quick commissioning	• Off	Normal operating mode
	• Flashing green	Quick commissioning active (LED 1 s on, 1 s off)
	• Green on	(for 10 s) device 0.1 or 1 is connected
	• Red on	(for 10 s) device 0.1 or 1 is not connected

Operating buttons

- | | |
|------------------------------------|--|
| 6 Remote ✓ | <ul style="list-style-type: none">• Long (> 6 s) Sends system reports to the email recipient of the fault (not to Energy indicator and trend data recipient) |
| 7 Service <input type="checkbox"/> | <ul style="list-style-type: none">• Short (< 2 s) State query device 0.1 (LPB) or 1 (BSB)• Long (> 6 s) Quick commissioning of plants with only a single connected controller |

Button combination

- | | |
|--------------------------------|---|
| ✓ and <input type="checkbox"/> | <ul style="list-style-type: none">• Long (> 6 s) Simultaneously press buttons ✓ and <input type="checkbox"/> to restore the device to the factory settings.
⚠: All configuration data and settings are reset. The device list, plant diagrams, and unsent messages are deleted. History data is not deleted. |
|--------------------------------|---|

Notes

Mounting

You can mount the web server in a panel, distribution box, or on a wall. Include space for wiring when planning. Make sure service can easily access the unit and the unit is ventilated properly.

- | | |
|--|---|
| <ul style="list-style-type: none">• Standard mounting• Wall mounting.• Mounting position• Mounting and dimensions | <ul style="list-style-type: none">On standard rail TH 35-7.5.Attached with 2 screws.Horizontal or vertical.See "Dimensions". |
|--|---|

Install

Important notes

Observe the following when installing:

- Run fuses, switches and wiring as per local regulations for electrical installations.
- We do not recommend plant monitoring via USB interface in environments with strong electromagnetic interference (e.g. in industrial environments with electrical welding equipment).
- See "Technical data" for electromagnetic compatibility.

Operating voltage

The supplied AC 230 V power supply provides the DC 24 V operating voltage for the web server.

Wiring

The operating voltage, USB and Ethernet plugs are located on the upper part of the housing.
The terminals on the device for the LPB/BSB bus are located under the removable cover.

Connection terminals

The connection terminals are designed for wire diameters of min. 0.5 mm or cross-sections of 0.25...1.5 mm² or stranded wire cross-sections of 0.25...1.0 mm².

Commissioning

Connections

The web server is commissioned using a web browser and, as an option, with ACS790.

The web server connects to the PC/Laptop via USB with the supplied cable or over Ethernet.

You can connect via Climatix IC or Synco IC as an alternative.

A quick commissioning mode is available on plants with only a single connected controller. Press the button to add a controller to the device list with address 0.1 (LPB) or 1 (BSB) and generate its device web page.

Additional information is available in the Mounting instructions M5712 inserted in the package or the Installation guide G5712 and commissioning instructions C5712, available in the Download Center at: <http://www.siemens.com/ozw672-manual>.

Router

A connection (e.g. DSL router) is required to connect directly via the Internet. The web server is not suitable for connecting directly to the Internet since it does not have a firewall; normally a component of the DSL router.

IP address

- The IP address via USB is set: **192.168.250.1**.
- Default setting for the IP address via Ethernet: **192.168.2.10**.
- The network administrator must provide an IP address for the web server before you can connect the web server via Ethernet to a managed network.

User groups	User accounts are created and assigned to specific user groups for customized user operation.
End-user	<ul style="list-style-type: none"> • Access to end-user data and fault overview. • Operate and monitor via menu tree and plant diagrams. • Administer own user accounts.
Technical service	<p>Same as end user. In addition:</p> <ul style="list-style-type: none"> • Access service data. • Create, download, and manage trend data • Download consumption data and message history. • Upload customized logos and documents. • System definitions update. • Firmware update • Update device web pages.
Administrator	<p>Same as service. In addition:</p> <ul style="list-style-type: none"> • Edit device list. • Create device web pages. • Create, copy, change, and delete plant diagrams. • Select "Energy indicator" data points and change the default values of the data points and/or "Green limits" as needed. • Administer all user accounts.

Maintenance

The OZW672.. web server is maintenance free (no battery changes, no fuses).
Clean the housing only with a dry towel.

Repair

The OZW672.. web server cannot be repaired on site. If faulty, return to the Repair Center at the relevant Regional Company.

Disposal



The device is considered electrical and electronic equipment for disposal in terms of the applicable European Directive and may not be disposed of as domestic garbage.

- Use only proper channels to dispose the device.
- Comply with all local, applicable laws and regulations.

Technical data

Power cable for web server OZW672..	Operating voltage	AC 230 V ± 15 %
	Rated voltage "Euro plug"	AC 230 V EN 50075 and VDE 0620-1
	Frequency	50/60 Hz
	Power consumption (including web server OZW672..)	3 VA typical
	Protection class	II.
	Output voltage	SELV 24 VDC
	Supply line fusing	Max. 16 A
	Cable length (distance from AC 230 V plug to web server)	Max. 1.6 m
Web server OZW672..	Operating voltage	SELV 24 VDC ± 5 %, 625 mA max.
	Power consumption	2 W typical
Functional data	Clock reserve	Min. 72 hours
	Device list	
	OZW672.01 OZW672.04 OZW672.16	1 LPB/BSB device Max. 4 LPB devices Max. 16 LPB devices
LPB/BSB bus	Interface type	2-wire connection
	2-wire bus	DB/CL+, MB/CL- (non-exchangeable)
	Bus load	E 5
	Permissible line length and cable types	See: Local Process Bus, System engineering, Basic documentation P2370
USB	Connection, screw terminals for	
	Solid/stranded wire (twisted or with ferrule)	Min. dia. 0.5 mm
	1 solid wire per terminal	0.25...1.5 mm ²
	1 stranded wire per terminal	0.25...1.0 mm ²
Ethernet	Interface type	100BaseTX, IEEE 802.3 compatible
	Bit rate	Max. 100 Mbps
	Protocol	TCP/IP
	Identification	Auto MDI-X
Digital inputs D1, D2	Connection, plug	RJ45 plug (screened)
	Cable type	Standard Cat-5, UTP or STP
	Cable length	Max. 100 m
Directives and standards	Voltage at an open contact	DC 17 V
	Current at closed contact	DC 5 mA
	Signal coupling	Potential free
	Contact type	Continuous contact
Environmental compatibility	Product standard	EN 60950-1 Information technology equipment – Safety
	EU conformity (CE)	CE1T5711xx ^{*)}
	RCM conformity	CE1T5711en_C1 ^{*)}
	EAC conformity	Eurasia conformity
Degree of protection	The product environmental declaration CE1E5711en ^{*)} contains data on environmentally compatible product design and assessments (RoHS compliance, materials composition, packaging, environmental benefit, disposal).	
	Protective category	IP30 to EN 60529
	Protection class	III as per EN 60950-1

*) The documents can be ordered at <http://siemens.com/bt/download>.

Ambient conditions	Operation	IEC/EN 60721-3-3
	Climatic conditions	Class 3K23
	Temperature (housing and electronics)	-0...+50 °C
	Humidity	5...95 % r. h. (non-condensing)
	Mechanical conditions	Class 3M11
	Transport	IEC/EN 60721-3-2
Climatic conditions	Class 2K12	
Temperature	-40...+70 °C	
Humidity	<95 % r. h.	
Mechanical conditions	Class 2K12	
Materials and colors	Upper housing section	PC + ASA, RAL 7035 (light-gray)
	Lower housing section	PC + ASA, RAL 5014 (dove blue)
Dimensions	Length x width x height (max. dimensions)	87.5 mm x 90.0 mm x 39.2 mm
Weight	Web server OZW672..	0.136 kg
	Web server with packaging, installation instructions, power unit, USB and Ethernet cable, cable ties.	0.589 kg
	Packaging	Cardboard box
Terms, abbreviations	Auto Medium Dependent Interface - Crossed	Auto-MDI(X)
	Boiler System Bus	BSB
	Climatix IC Internet portal	Climatix IC
	Dynamic Domain Name System	DynDNS
	Dynamic Host Configuration Protocol	DHCP
	HVAC Integrated Tool von Siemens	HIT
	Hyper Text Transfer Protocol	HTTP
	Hyper Text Transfer Protocol Secure	HTTPS
	Internet Protocol	IP
	Local Process Bus	LPB
	Network Address Translation	NAT
	Network Time Protocol	NTP
	Port and Address Translation	PAT
	Remote Network Driver Interface Specification	RNDIS
	Shielded Twisted Pair	STP
	Simple Mail Transfer Protocol	SMTP
	Synco IC Internet portal	Synco IC
	Transport Layer Security	TLS
	Transmission Control Protocol	TCP
	Universal Serial Bus	USB
	Unshielded Twisted Pair	UTP
	Virtual Private Network	VPN
	Web Application Programming Interface	Web API

Connection diagrams

Connection diagram

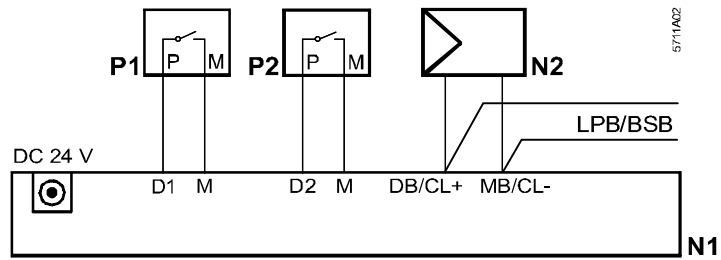

- N1 Web server
 N2 LPB/BSB device
 P1, P2 Devices with potential-free contact output for fault indication

Connection terminals

LPB/BSB bus

Digital inputs

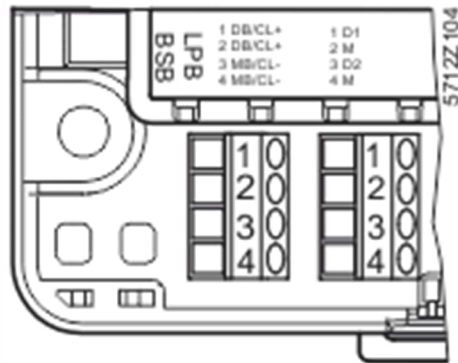

LPB/BSB

- 1 DB/CL+
- 2 DB/CL+
- 3 MB/CL-
- 4 MB/CL-

Digital

- 1 D1
- 2 M
- 3 D2
- 4 M

Operating voltage

DC 24 V



- 1 DC 24 V (+)
- 2 GND (-)



Dimensions

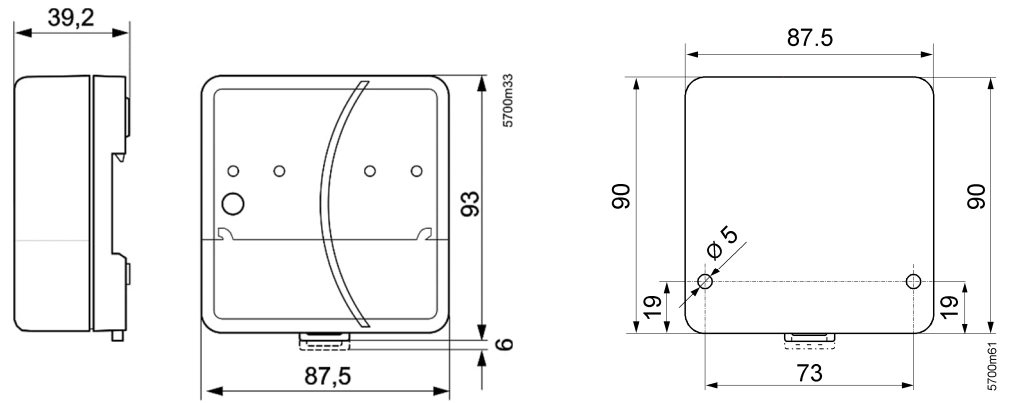

Published by:
Siemens Switzerland Ltd.
Smart Infrastructure
Global Headquarters
Theilerstrasse 1a
CH-6300 Zug
Switzerland
Tel. +41 58-724 24 24
www.siemens.com/buildingtechnologies

© Siemens Switzerland Ltd 2018
Delivery and technical specifications subject to change